

Anschlussstück F nach DIN 42551 F

Connection Pipe F in Accordance with DIN 42551 F

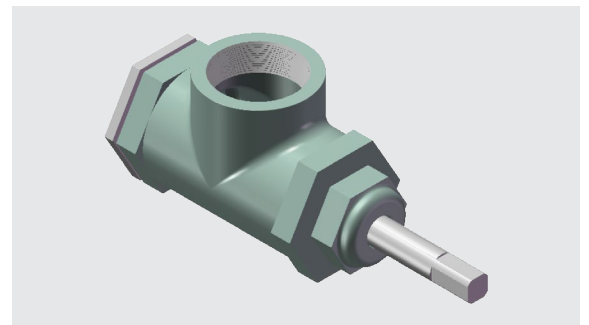
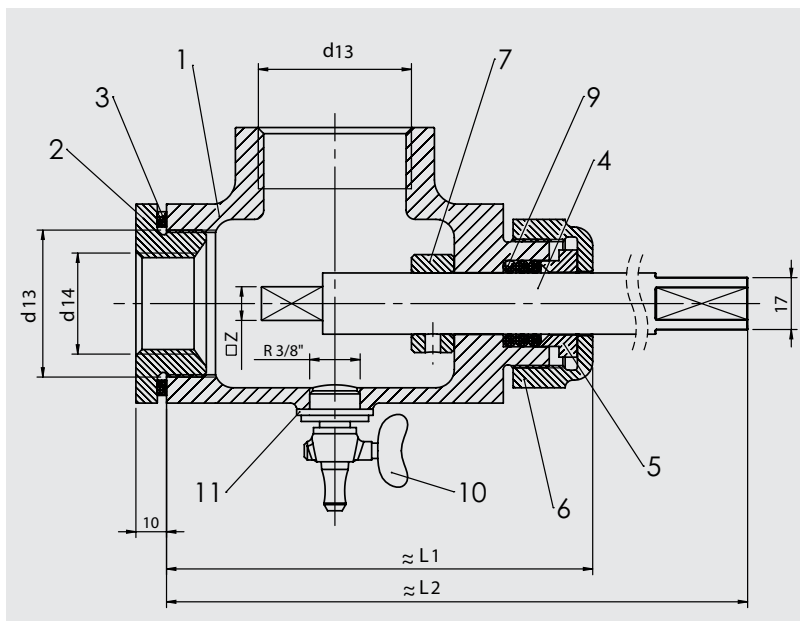

Anschlussstück Connection Pipe	NW	d13	d14	L1	L2	Z
F 22/31 DIN 42551	22	M 48 x 1,5	M 33 x 1,5	145	260	11
F 31/40 DIN 42551	31	M 60 x 2	M 48 x 1,5	180	270	17
F 31 DIN 42551	31	M 48 x 1,5	-	145	260	17
F 40 DIN 42551	40	M 60 x 2	-	180	295	17

Pos. Item	Stück Qty	Bezeichnungen Descriptions	F22/31 DIN 42551	F31/40 DIN 42551	F31 DIN 42551	F40 DIN 42551	Bemerkungen Remarks
1	1	Gehäuse housing	G 65 DIN 42551	G 80 DIN 42551	G 65 DIN 42551	G 80 DIN 42551	GG-18
2	1	Zwischenstück reduction	H22/31 DIN 42551	H 31/40 DIN 42551	-		GG-18
3	1	Flachdichtung gasket	D 31 DIN 42551	D 40 DIN 42551	-		
4	1	Welle spindle	K 1 DIN 42551	K 2 DIN 42551	K 3 DIN 42551	K 3 DIN 42551	S235JR (1.0037)
5	1	Stopfbuchse packing gland			L DIN 42551 / S235JR (1.0037)		
6	1	Überwurfmutter union nut			N DIN 42551		
7	1	Stelling adjusting ring			B 20 DIN 705 / S235JR (1.0037)		
9	1	Dichtung gasket			4 x 4 x 320		
10	1	Ablaßhahn drain cock			3/8" Messing brass		
11	1	Dichtring gasket			17 x 28 x 2 / PA		

Zubehör Accessory parts	Reduzierung des seitlichen Abgangs d13 auf Rohrgewinde Reduction of lateral connection thread d13 to pipe thread	Passend für Anschlussstück Suitable for connection pipe
42551 F H22/1"	Reduzierung reduction M 48 x 1,5 zu to 1" Innengewinde internal thread	F 22 / 31 DIN 42551 / F 31 DIN 42551
42551 F H40/1 1/2"	Reduzierung reduction M 60 x 2 zu to 1 1/2" Innengewinde internal thread	F 3 / 40 DIN 42551 / F 40 DIN 42551